

Let op !

Waterleidingen eerst goed doorspoelen voordat u uw kraan aansluit !

Gebruik voor reiniging geen chloor, schuurmiddelen of andere agressieve schoonmaakmiddelen !

Controleer voor installatie of onderstaande onderdelen aanwezig zijn

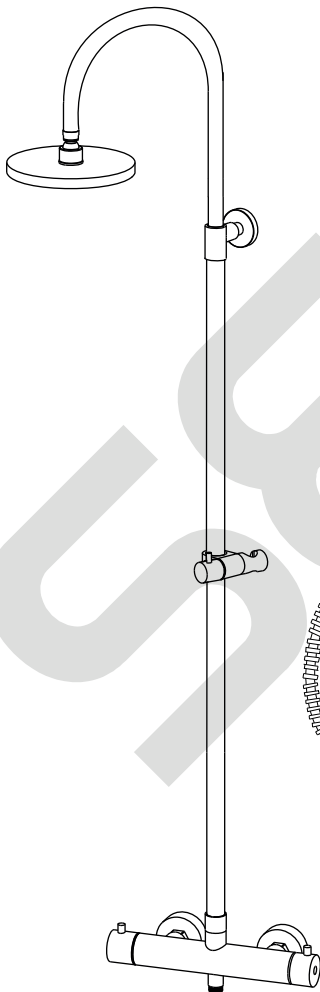

Benodigd gereedschap



schroevendraaier

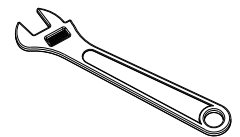

verstelbare
moersleutel



Inbussleutel
(meegeleverd)

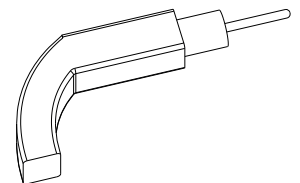

Boormachine

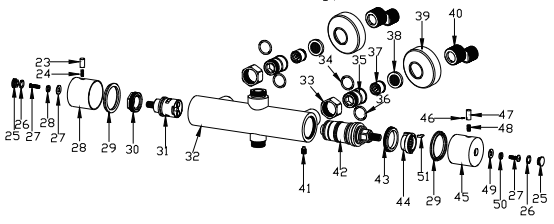
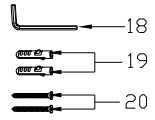
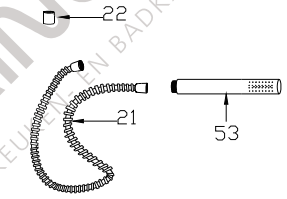
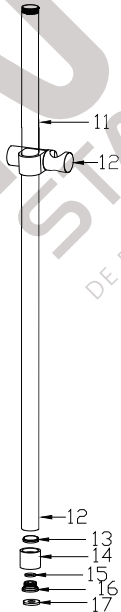
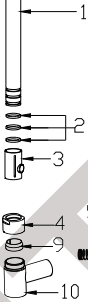
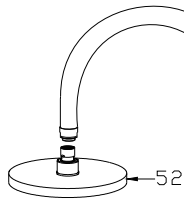

SEAMLESS®
DE RVS KEUPELEN BADKAMERKRANEN

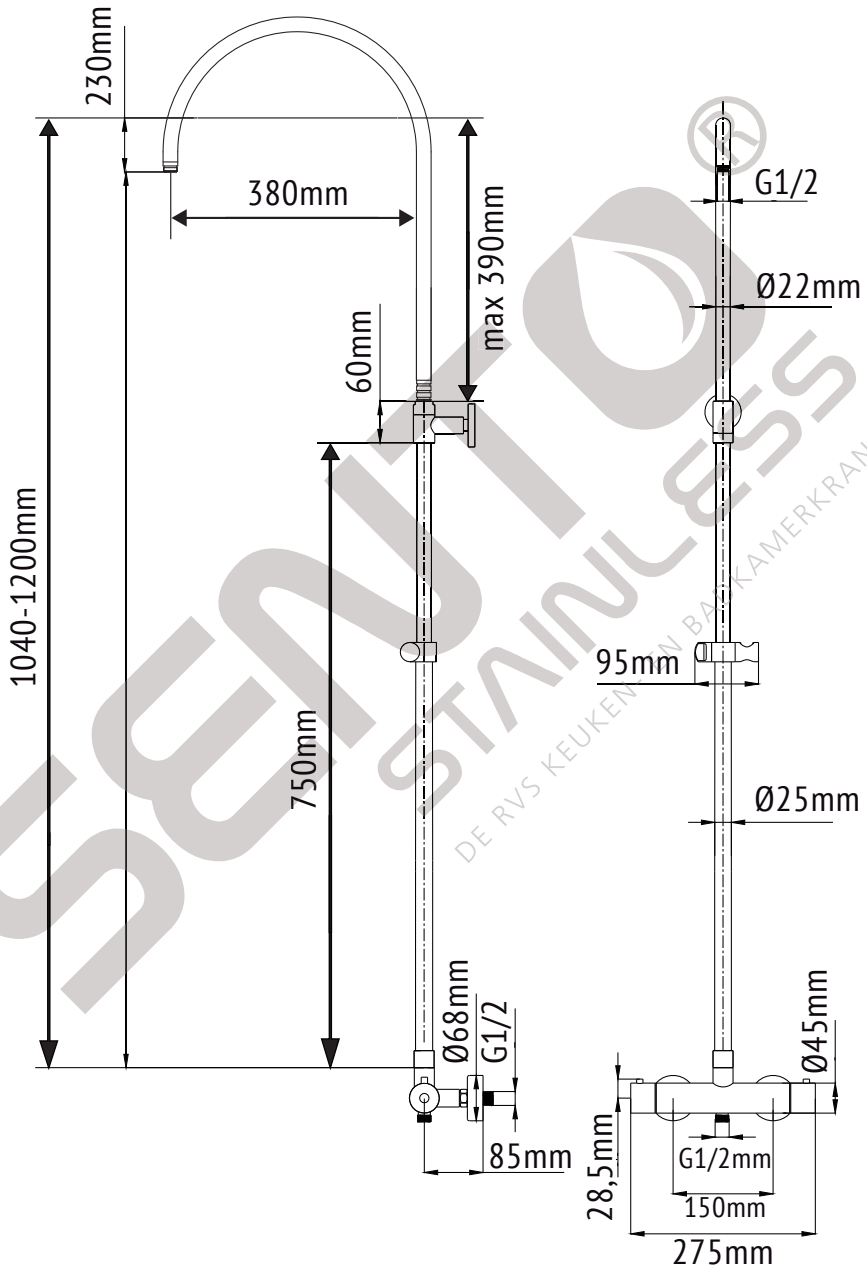

Installatie procedure

Stap 1

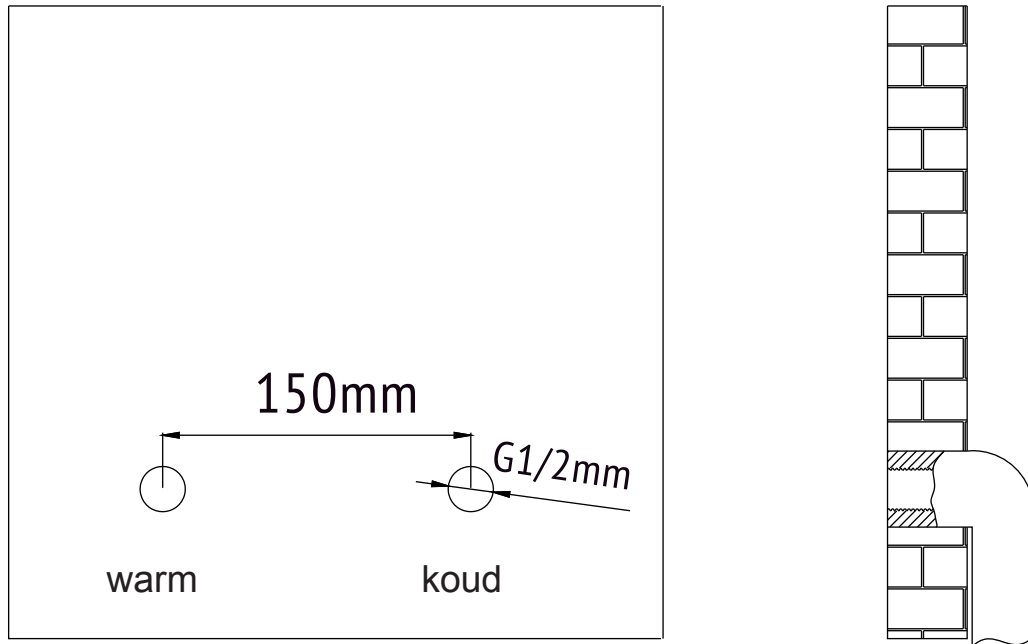

Stap 2

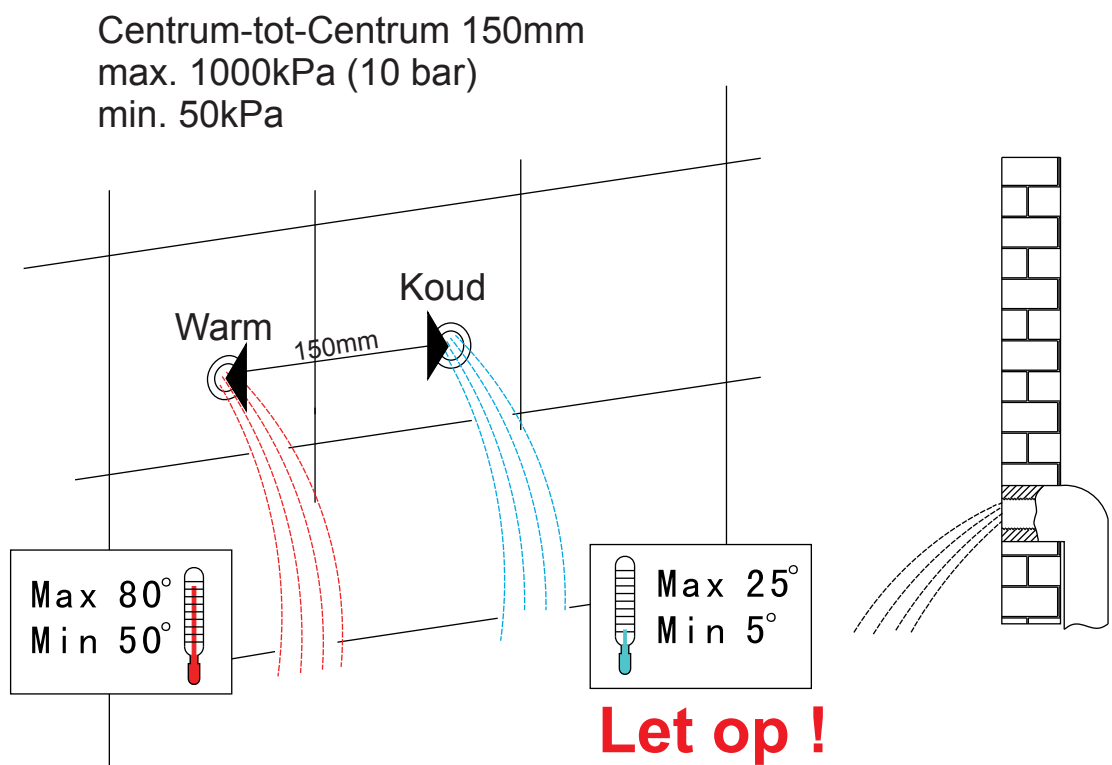

Let op !

Waterleidingen eerst goed doorspoelen
voordat u uw kraan aansluit

Step 3

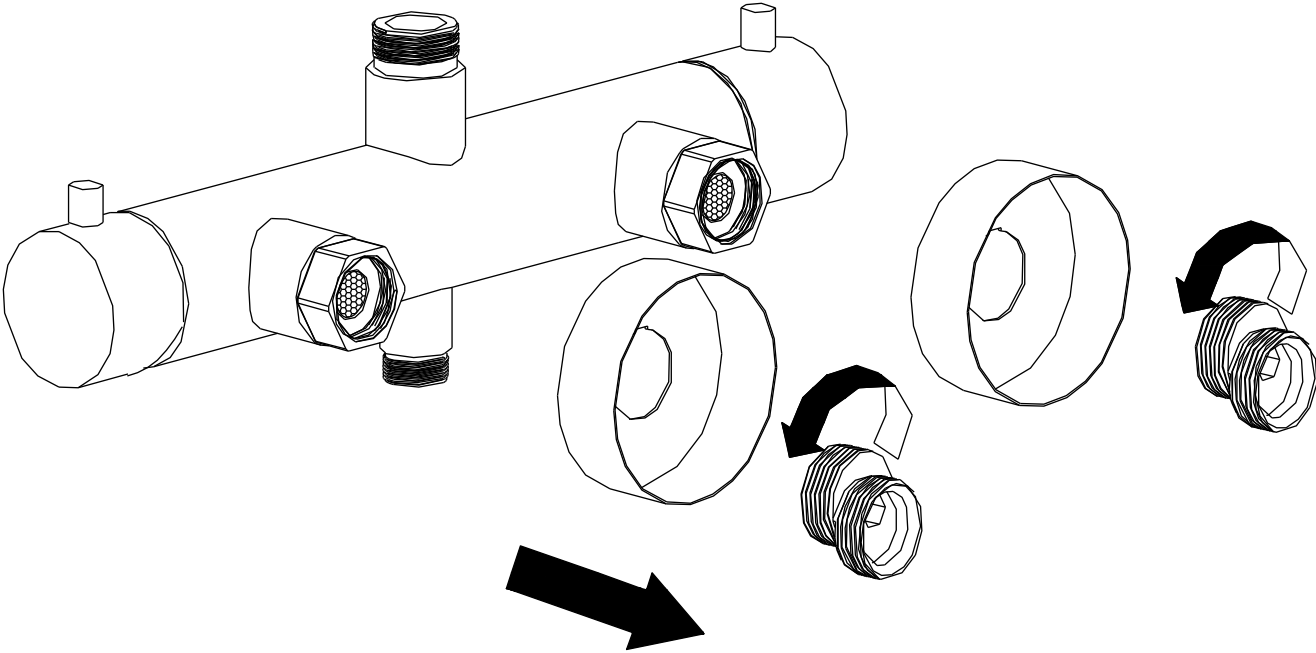

Step 4

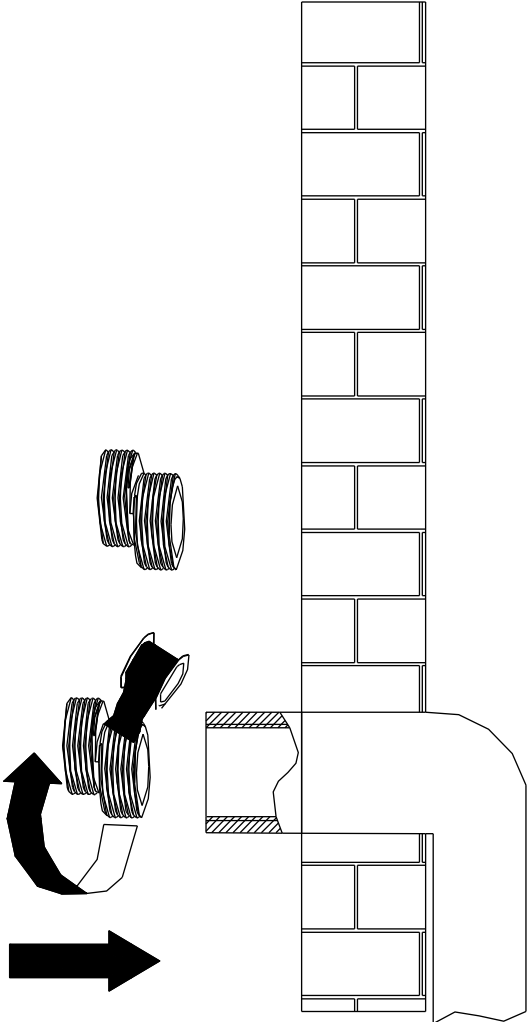

Step 5

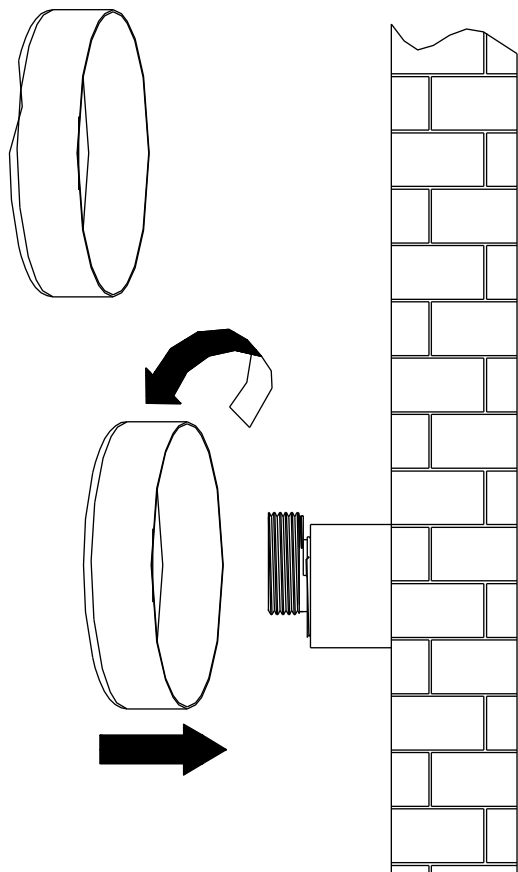

Step 6

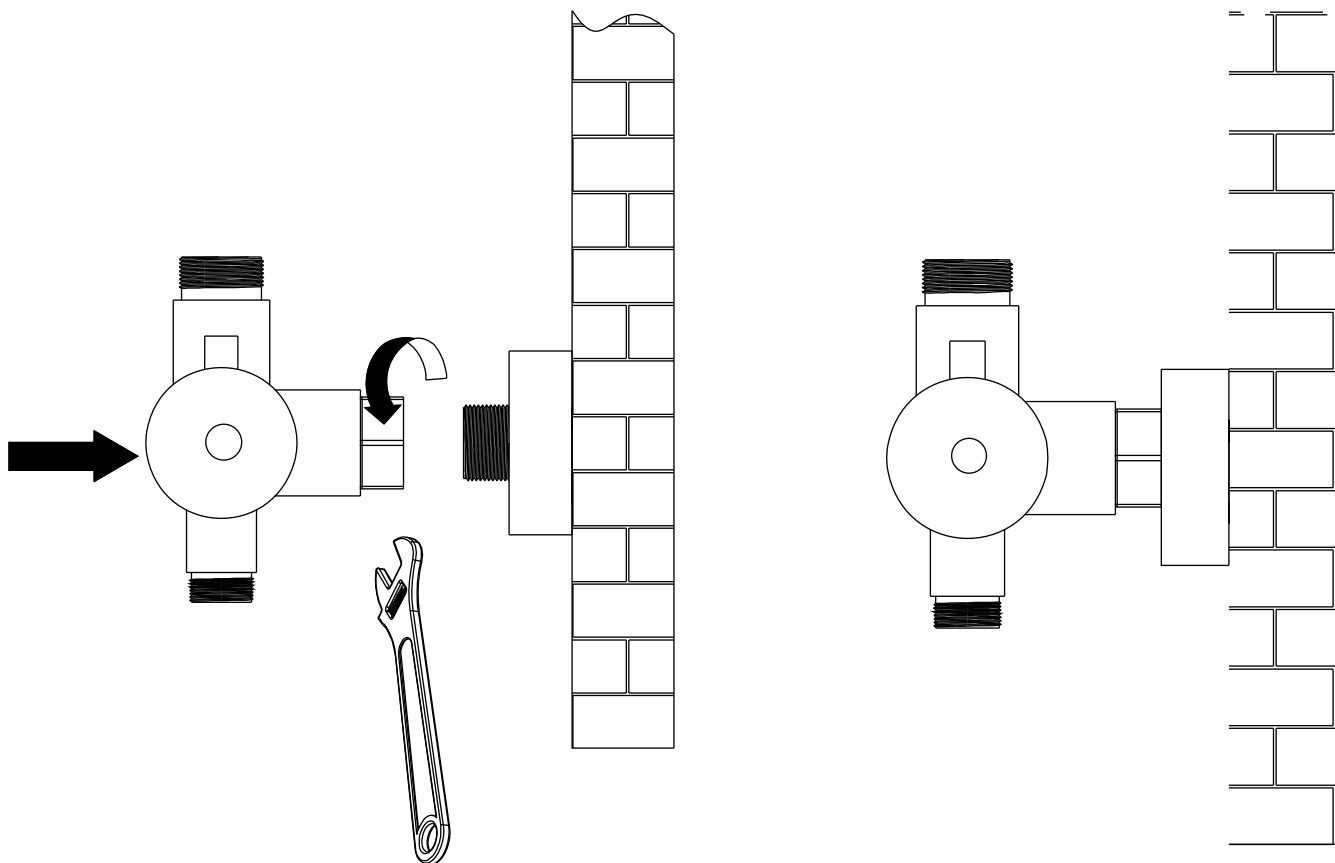

Step 7

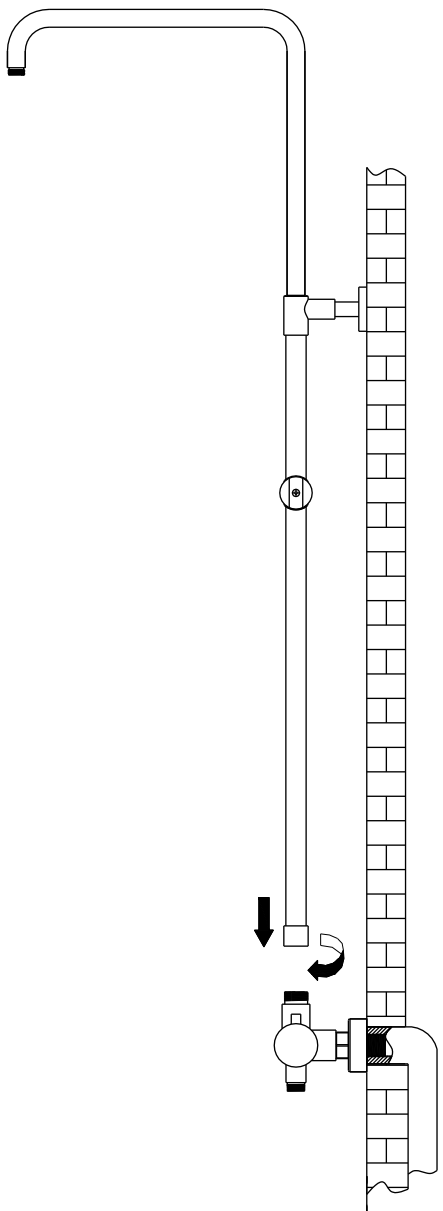

Step 8

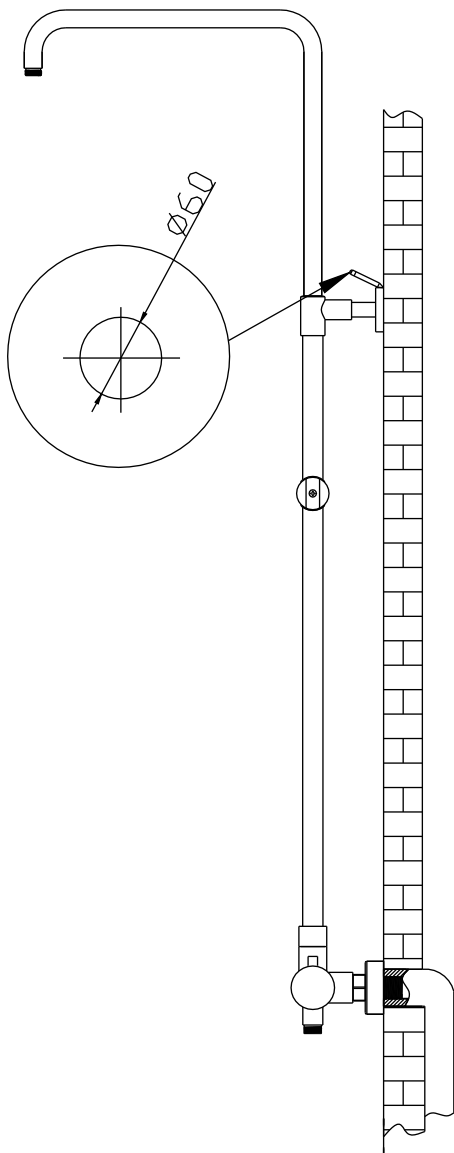

Step 9

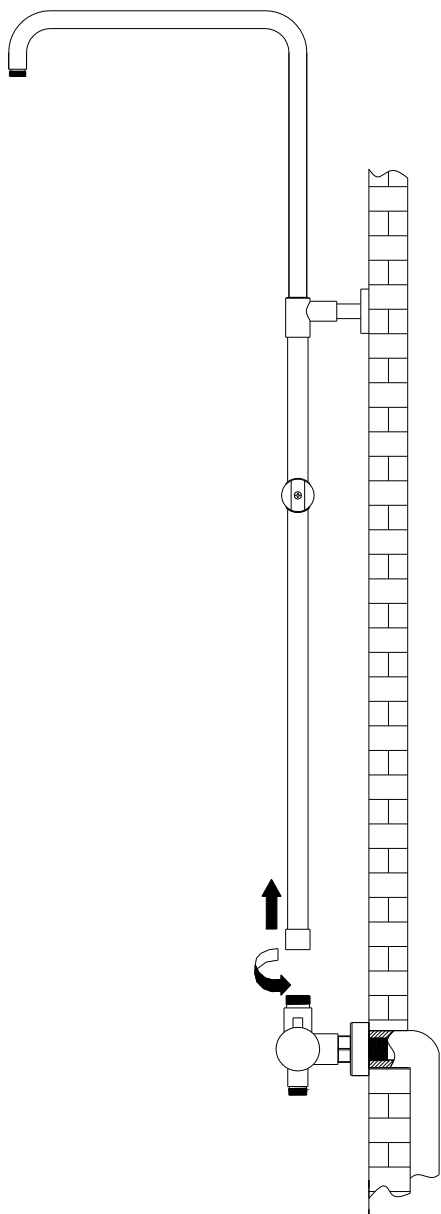

Step 10

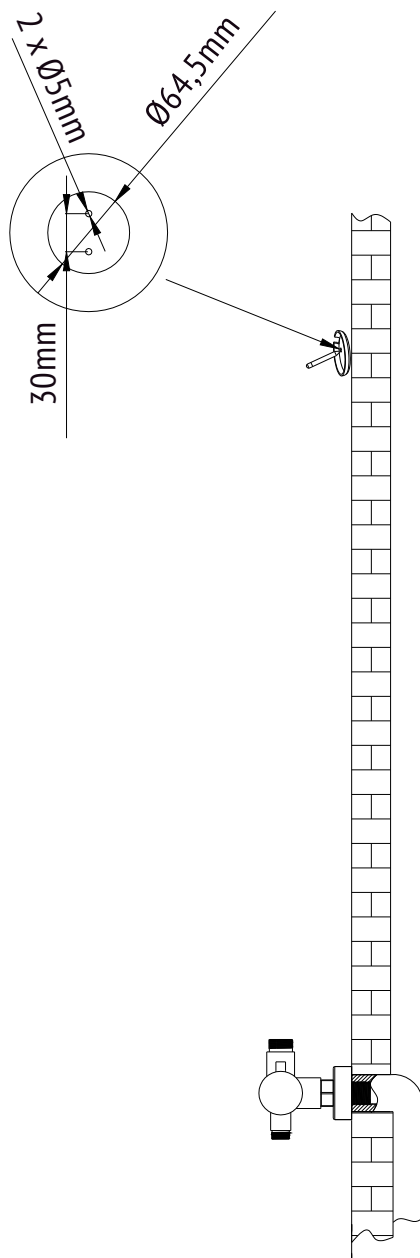

Stap 11

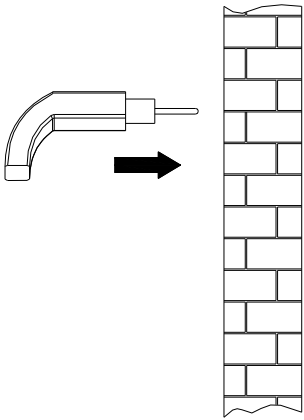

Stap 13

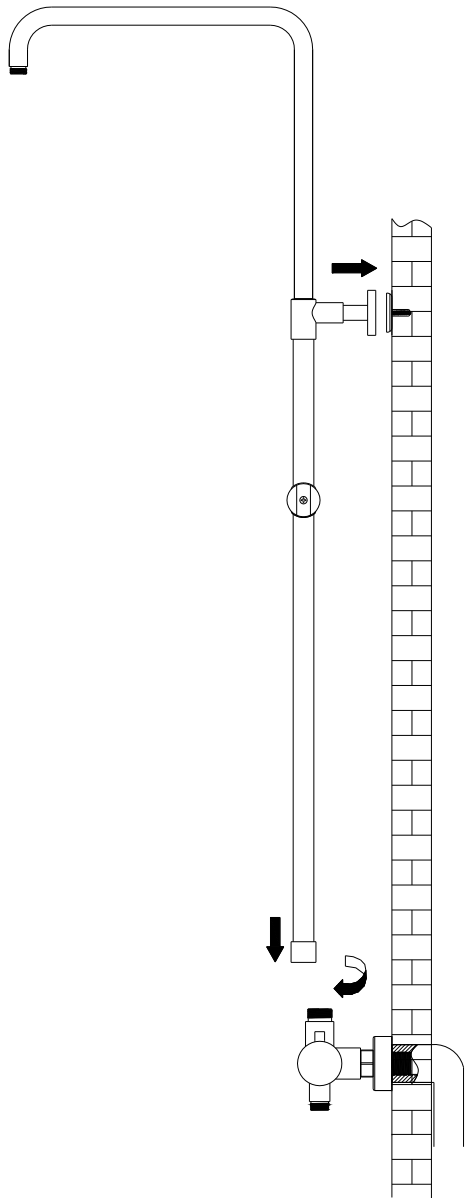

Stap 12

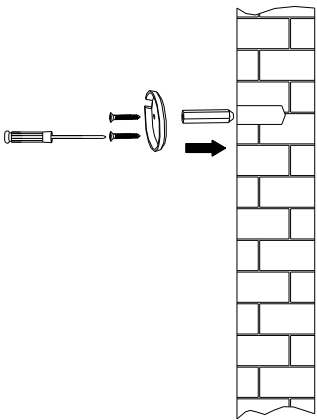

Step 14

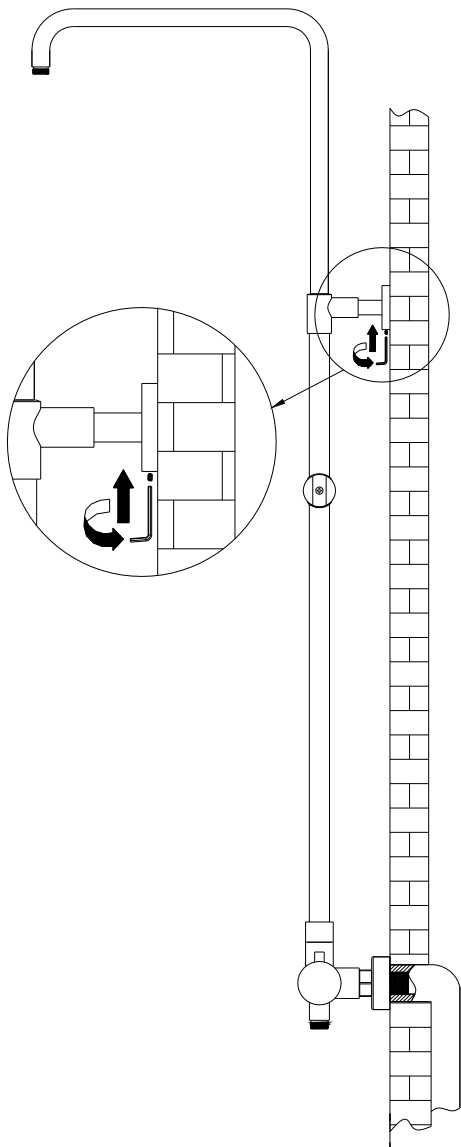

Step 15

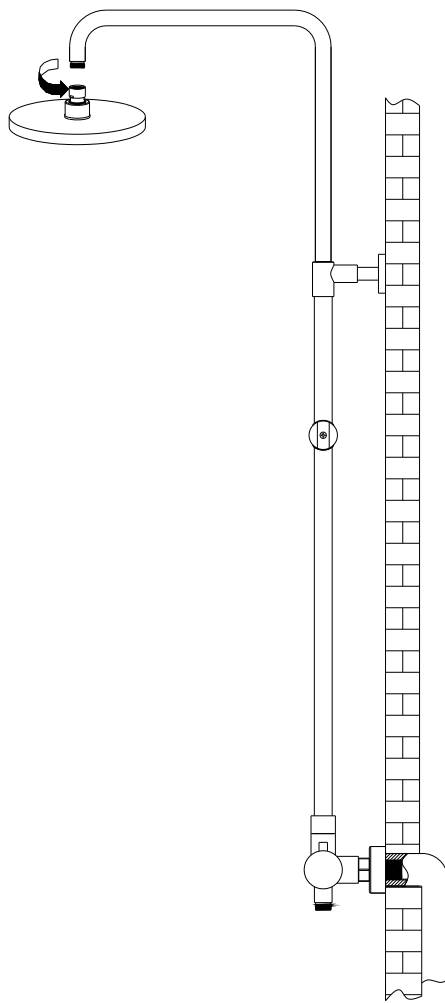

Stap 16

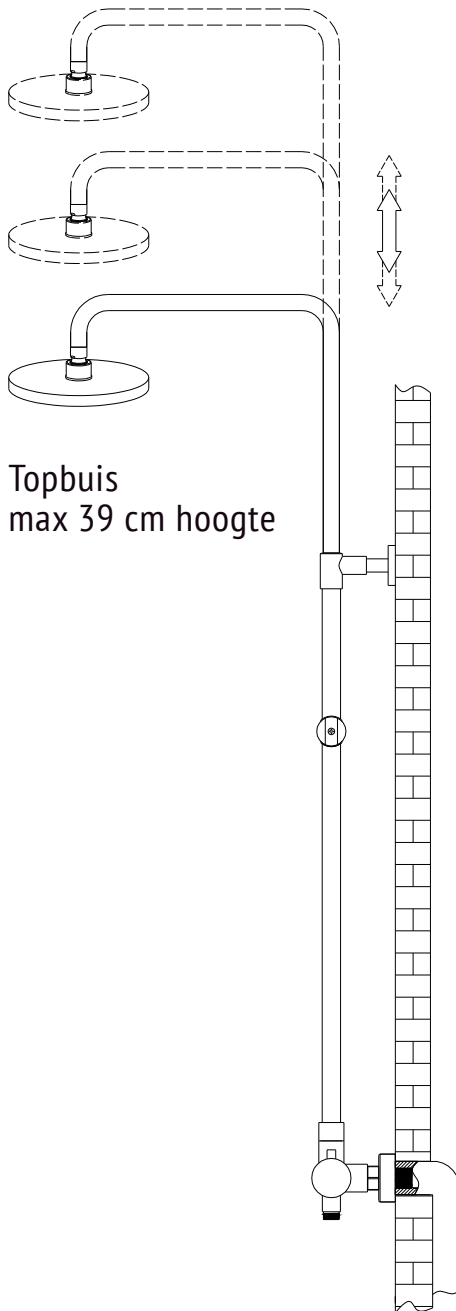

Stap 17

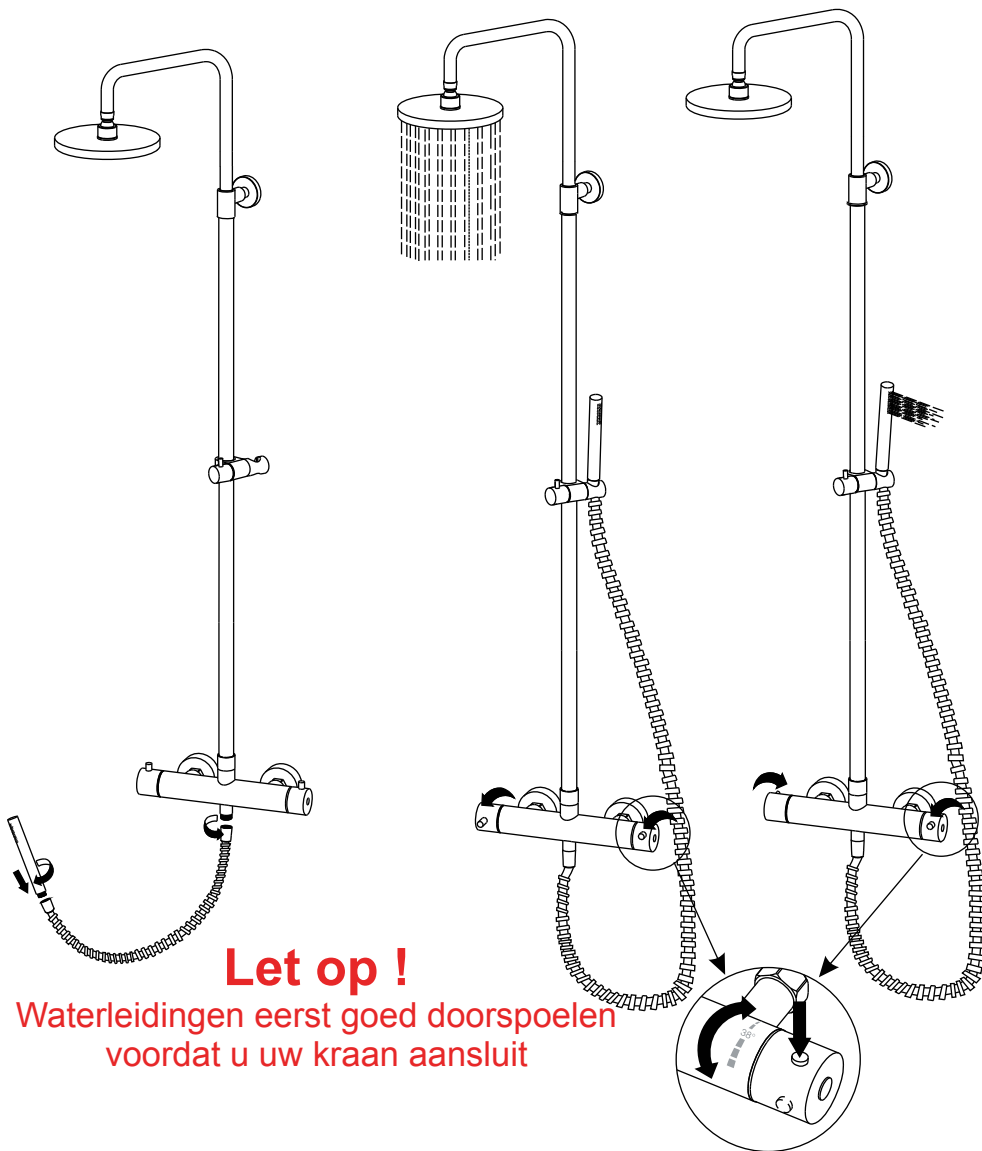

Let op !

Waterleidingen eerst goed doorspoelen
voordat u uw kraan aansluit

Stel de juiste temperatuur in
door de knop in te drukken
en de grote knop naar de juiste
temperatuur te draaien

SENTO
STAINLESS
DE RVS KEUKEN- EN BADKAMERKRANEN